

DIBUJO ILUSTRATIVO

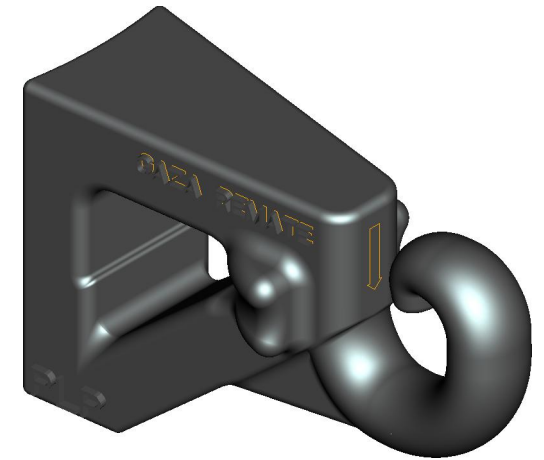
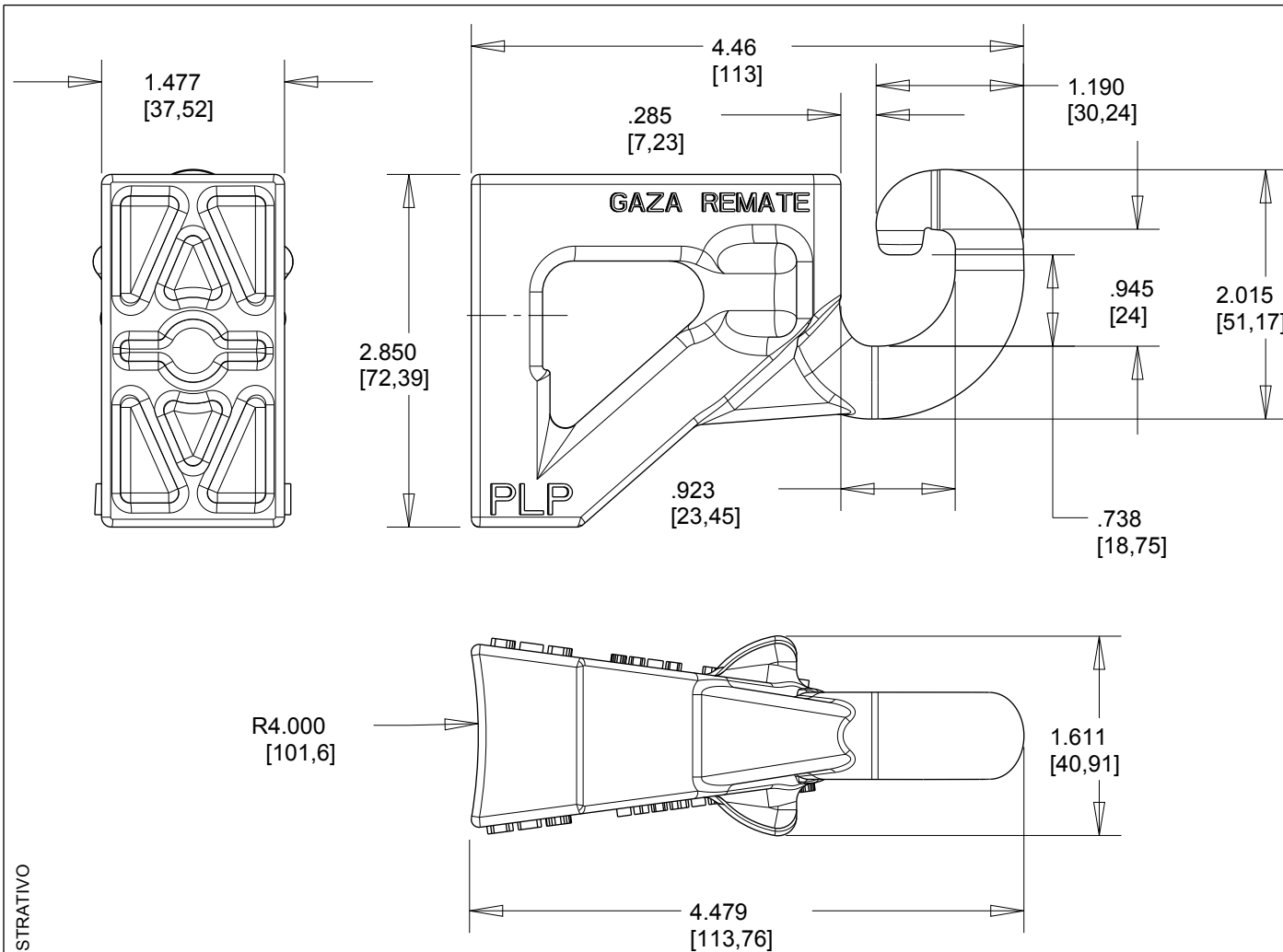

Notas:

Masa aproximada pieza : 0.649 LB [0.295 Kg]

REV	FECHA DE REV	DIBUJO	ING	CAL	NUMERO DE CAMBIO	DESCRIPCION
			APROB	APROB		TITULO DE DIBUJO PARA CLIENTE
						12520001 - GFA - Gancho Fiberling de aluminio
						TOLERANCIAS NO INDICADAS .xx ± .XX[.X] .xxx ± .XXX[.XX] ANGULO X°
						UNIDADES pulgadas[mm] SIN ESCALA PROYECCION EN TERCER ANGULO
						<b>PREFORMED LINE PRODUCTS</b> Preformados de México
						CONFIDENCIAL ESTE DIBUJO ES PROPIEDAD EXCLUSIVA DE PREFORMED LINE PRODUCTS COMPANY Y SOLO PUEDE SER USADO CON PREVIA AUTORIZACION DE PLP
		DIBUJO:	FECHA:	NUMERO DE CATALOGO PLP	NUMERO DE PARTE PLP	
		EDUARDO	08/07/2013	GFA	12520001	
		APROBO:	FECHA:	CLIENTE:	NUMERO DE DIBUJO PLP	
				GFA	GFA	
		APROBO:	FECHA:	HOJA No.	TAMANO DE HOJA	REV
				1 de 4	A	00

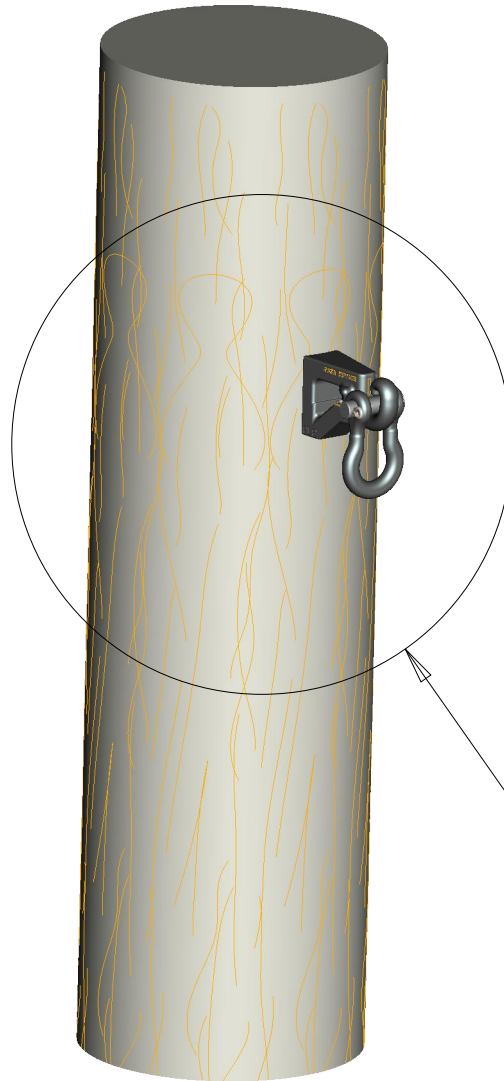
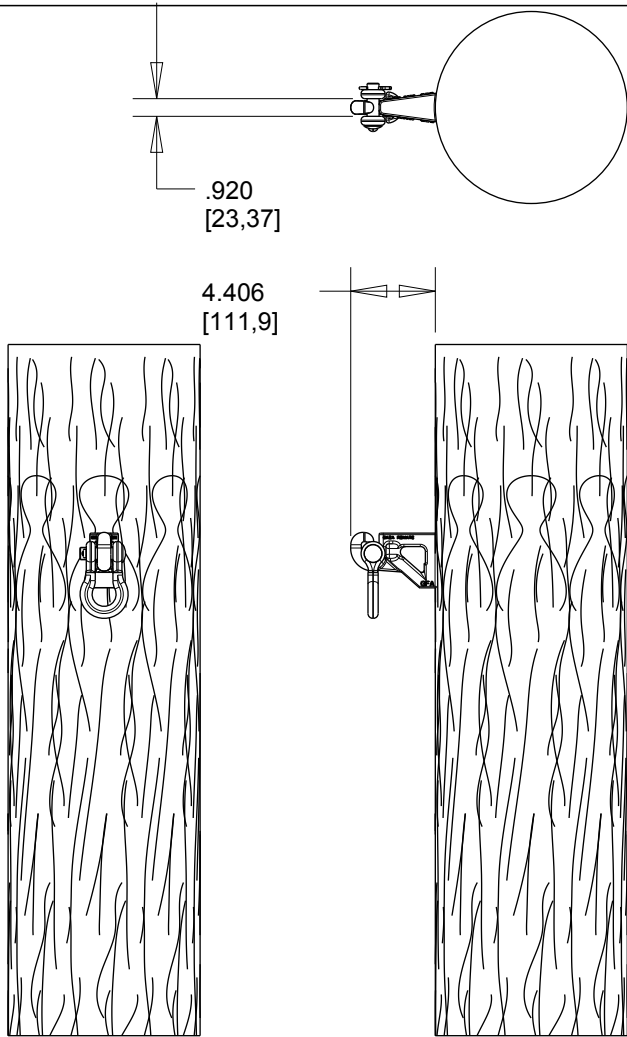

DETAIL A  
SCALE 0.300

SEE DETAIL A

00	09/07/2013						EMISION INICIAL
----	------------	--	--	--	--	--	-----------------

REV	REV DATE	DRWN	APVD	APVD	CHANGE NUMBER	DESCRIPTION
-----	----------	------	------	------	---------------	-------------

CUSTOMER DRAWING TITLE						TOLERANCES UNLESS NOTED	UNITS
<b>ENSAMBLE GANCHO FIBERLING CORTO DE ALUMINIO TELECOM CON GRILLETE "SUSPENSION"</b>						.xx ± .XX	<b>DO NOT SCALE</b>
						.xxx ± .XXX	THIRD ANGLE PROJECTION
						x/xx ± X/XX	
						ANGLES X°	

<b>PREFORMED LINE PRODUCTS</b> Preformados de México				(PLP MEXICO)	
CONFIDENTIAL THIS DRAWING IS THE EXCLUSIVE PROPERTY OF PREFORMED LINE PRODUCTS COMPANY AND IS TO BE USED ONLY WITH THE PRIOR EXPRESSED PERMISSION OF PLP					
DRWN:	DATE:	PLP CATALOG NUMBER	PLP PART NUMBER		
EDUARDO	08/07/2013	<b>GFA</b>	<b>12520001</b>		
APVD:	DATE:	CUSTOMER I.D. NUMBER	PLP DRAWING NUMBER		
			<b>GFA</b>		
APVD:	DATE:	SCALE	SHEET No	PLP ORIGIN NUMBER	REV
		1.25 : 1.00	2 OF 4		<b>00</b>

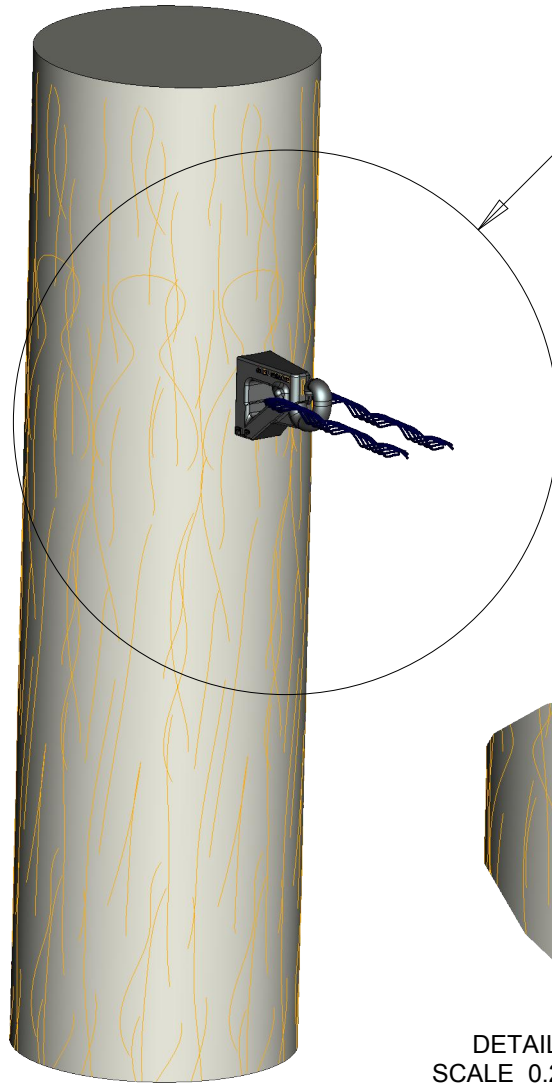
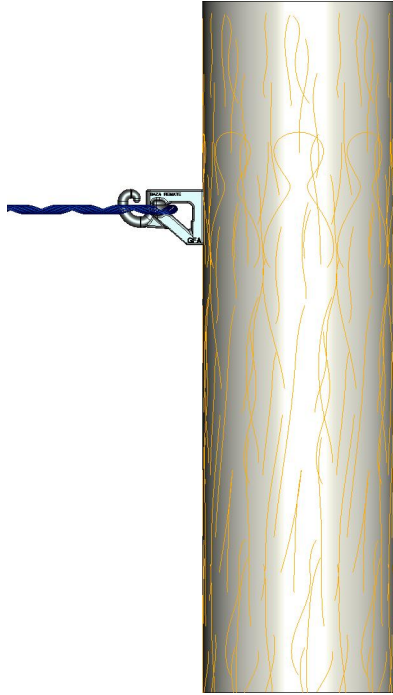

SEE DETAIL B

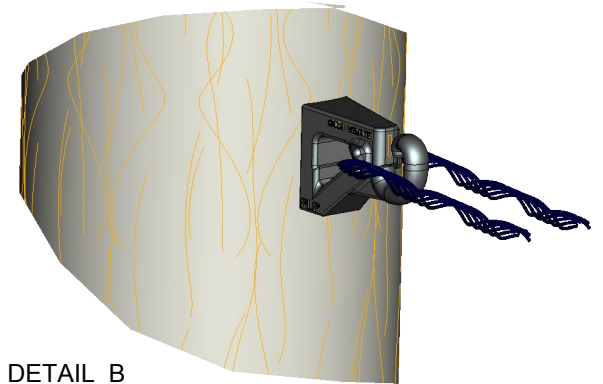

DETAIL B  
SCALE 0.200

SCALE 0.100

00	09/07/2013					EMISION INICIAL
REV	REV DATE	DRWN	APVD	APVD	CHANGE NUMBER	DESCRIPTION



(PLP MEXICO)

CONFIDENTIAL  
THIS DRAWING IS THE EXCLUSIVE PROPERTY OF PREFORMED LINE PRODUCTS COMPANY  
AND IS TO BE USED ONLY WITH THE PRIOR EXPRESSED PERMISSION OF PLP

CUSTOMER DRAWING TITLE						TOLERANCES UNLESS NOTED	UNITS
<b>ENSAMBLE GANCHO FIBERLING CORTO DE ALUMINIO TELECOM CON REMATE "TENSION"</b>						.xx ± .XX	INCH
						.xxx ± .XXX	DO NOT SCALE
						x/xx ± X/XX	THIRD ANGLE PROJECTION
						ANGLES X°	

DRWN: EDUARDO	DATE: 08/07/2013	PLP CATALOG NUMBER: GFA	PLP PART NUMBER: 12520001
APVD: --	DATE: --	CUSTOMER I.D. NUMBER: --	PLP DRAWING NUMBER: GFA
APVD: --	DATE: --	SCALE: 0.15 : 1.00	SHEET No: 3 OF 4
		PLP ORIGIN NUMBER: --	REV: 00